

Directional poppet valves

Type WVH-6I

NG 6 ISO
up to 25 l/min, up to 700 bar

Features

- Directly operated
- Poppet tight (bidirectional)
- High operational safety and reliable switching
- High duty cycles and long lifetime
- High corrosion resistance
- Replacement of coils without opening of the pressure tight spaces



Applications

- Controlling of cylinders in higher pressure ranges as full replacement for spool valve technology (especially for poppet tight holding and bending)
- Clamping technology & jig construction
- Machine tools - auxiliary functions
- Forming technology - clamping
- Presses, test benches and systems
- Lifting and transport systems
- Hydraulic tools

Design

- Patented valve-design
- Pressure compensated design of hardened and specially grinded valve cones
- Strong return springs
- Hidden manual override
- Available as 2/2 and 3/2 directional poppet valves with solenoid actuation
- 360° turnable and exchangeable plug-in coil

Technical data

Hydraulic fluid	mineral oil according to DIN 51524 (other fluids on request)
Fluid temperature range	- 20 to 80 °C
Ambient temperature range	- 30 to 50 °C
Viscosity range	5 to 400 mm ² /s
Porting	NG 6 according to DIN 24340 / ISO 4401/ CETOP RP 121 H
Max. operating pressure connection P, A, B	700 bar
Max. operating pressure connection T	700 bar
Max. flow rate	25 l/min, see switching capacity diagram page 5
Filtration (recommendation)	according to NAS 1638 class 6 or ISO/DIN 4406 17/15/12
Duty cycle DC	100 %
Solenoid voltage (nominal power)	12 VDC (26.7 W), 24 VDC (27.2 W), 110 VAC (25 W), 230 VAC (25 W)
Voltage tolerance	+/- 10 %
Switching time	see table on page 6
Degree of protection	IP 65 according to EN 60529 / DIN 40050 (or according coil choice)
Service life	B10: 1 million according to ISO 19973
Weight	see overview „Product information“
Material/Surface finish	solenoid coil: ZnNi-plated (1000 h salt spray test) valve body: 1.4104 / X14CrMoS17

Type WVH-6I

NG 6 ISO
up to 25 l/min, up to 700 bar

Type code

Example		WV	H	-	6I	-	2	/	2	-	E4	-	24	-	V	-	A		00	
Directional poppet valves																				Design 00 ... 99 For internal purposes
Size	700 bar																			
Nominal size	6 ...																			
Connection ISO	... I																			
Number of ports	2 or 3																			
Number of positions	2																			
Control function	see overview „Product information“																			
Control method	0 without solenoid 12 solenoid 12 VDC 24 solenoid 24 VDC 110 solenoid 110 VAC 230 solenoid 230 VAC																			
Seal material	V FKM																			
																				Index Please leave blank For internal purposes
																				Design revision For internal purposes

Product information

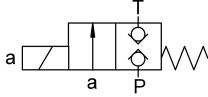
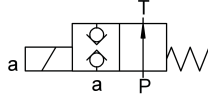
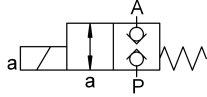
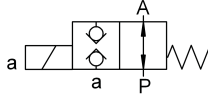
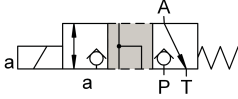
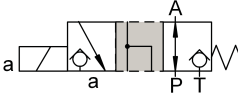
Valve type	2/2			
Control function	E4	BE4	E2	BE2
Part No. without coil	4682226	4682227	4682228	4682229
Part No. 12 VDC	on request	on request	on request	on request
Part No. 24 VDC	4674806	4674807	4674808	4674810
Part No. 110 VAC	4685060	4685057	4685059	4685055
Part No. 230 VAC	4682255	4682256	4682257	4682258
Symbol				
Weight (with solenoid coil)	1,3 kg	1,3 kg	1,3 kg	1,3 kg
Valve type	3/2			
Control function	X	C		
Part No. without coil	4682230	4682231		
Part No. 12 VDC	on request	on request		
Part No. 24 VDC	4674811	4674812		
Part No. 110 VAC	4699054	4699096		
Part No. 230 VAC	4699095	4699097		
Symbol				
Weight (with solenoid coil)	1,3 kg	1,3 kg		

Dimensional drawings

2/2 and 3/2 directional poppet valves

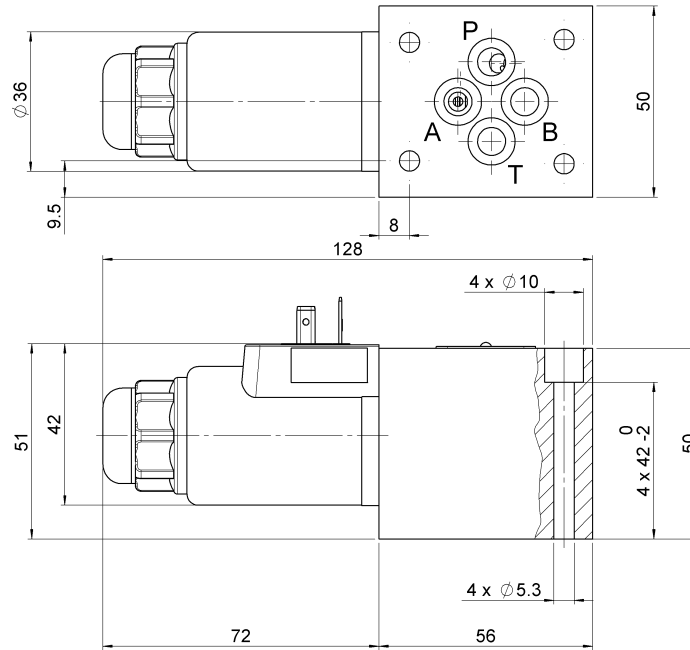

Drilling pattern

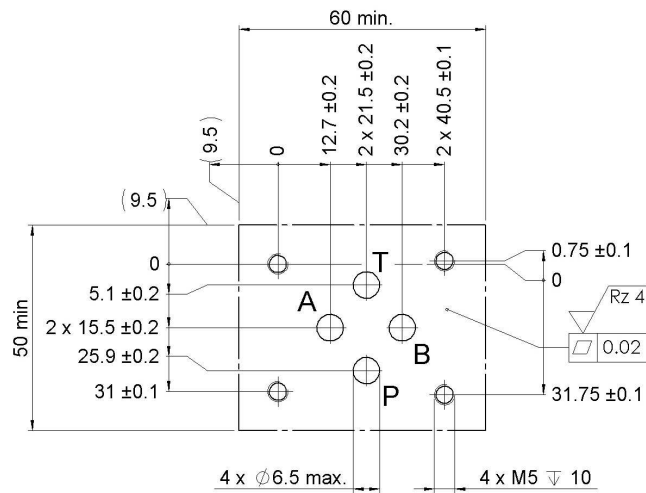

Pressure drop

($v = 15 \text{ mm}^2/\text{s}$)

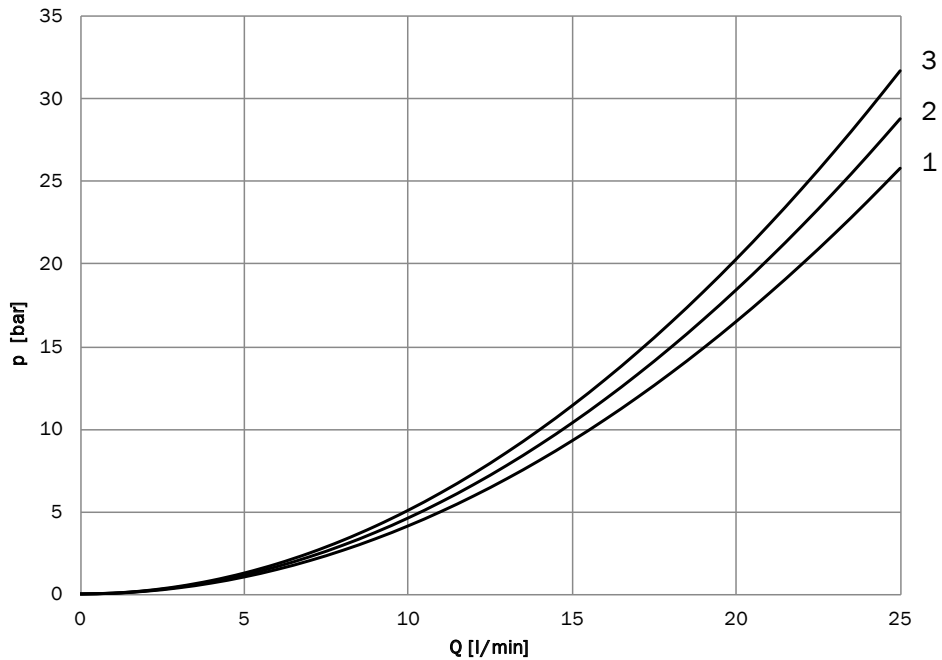

Valve type	Control function	a (switched)					0 (initial position)				
		P - A	P - B	A - T	B - T	P - T	P - A	P - B	A - T	B - T	P - T
2/2	E4					2					
2/2	BE4										2
2/2	E2	1									
2/2	BE2						2				
3/2	X	2								1	
3/2	C			2			3				

Hydraulic switching capacity

Hydraulic switching capacity at nominal operating voltage and at operating temperature.

Switch on current $I_{ON} \geq 0.7 \times I_N$

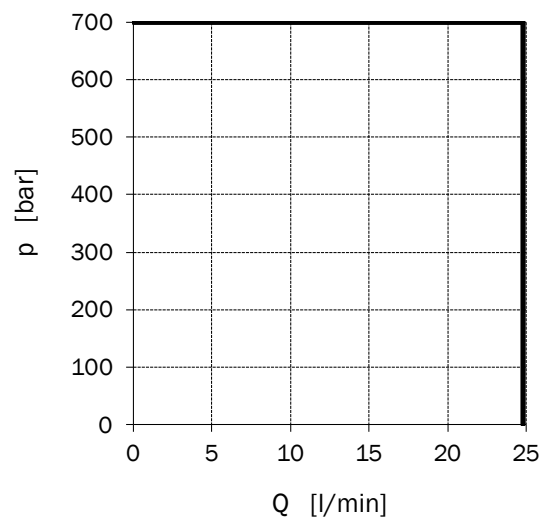

Type WVH-6I

NG 6 ISO
up to 25 l/min, up to 700 bar

Switching times

Valve type	Control function	Switching on [ms]*		Switching off [ms]*
		at operating temperature (0.7 x I _N)	cold (1 x I _N)	
2/2	E4, BE4	40	35	15
2/2	E2, BE2	40	35	15
3/2	X, C	40	35	15

* indicative values

Accessories

Electrical connection / solenoid variants

As an option to the standard version with the 24 VDC solenoid coil, all solenoid coils of the Coil-50-1836 series can be used according to the table. For this purpose, the valve „without solenoid coil“ (control method „0“ in the type code) and the solenoid coil must be ordered separately and installed by the customer.

The coil nut and the sealing ring are included in the scope of delivery of the valve.

Connection	DIN 436050	Junior Timer	Deutsch DT04
	radial	axial	axial
Protection ¹	IP65	IP67	IP67
12 V Part No.	915151	3001033	3091665
24 V Part No.	915142	3001503	3091667
110 VAC Part No.	3019735 ²	on request	on request
230 VAC Part No.	3019736 ²	on request	on request

¹ Important note: The protection class applies to the solenoid coil. The prerequisite for this is the correct assembly of the mating connector and the same or better type of protection of the mating connector itself is a necessity.

² Rectifier is integrated in the solenoid coil

Plug for solenoid

Part description	Part No.
1 x Plug for solenoid grey	6132484
1 x Plug for solenoid black	3728850
1 x LRS KPL Z4 TR 2Pol LED (power reduction plug)	3689354

Spare parts

Part description	Part No.
4 x O-Ring 9.25 x 1.78, FKM	4455692
1 x O-Ring 17.96 x 2.62, FKM	6287359
1 x O-Ring 24 x 1.5, FKM	6287362
4 x Socket head screw ISO 4762-M5 x 50-12.9	4455691
1 x Pole tube nut	4422997

Further fastening elements see technical data sheet AP700/RP700/EP700

Bieri Hydraulik AG

Könizstrasse 274
CH-3097 Liebefeld
Tel. +41 31 970 09 09 | Fax +41 31 970 09 10
info@bierihydraulics.com | www.bierihydraulics.com

The information in this brochure relates to the operating conditions and applications described.

For applications and operating conditions not described, please contact the relevant technical department.

Subject to technical modifications.